

- Platform bracket kit for 9301-E/9308-E/7957
- 4 bottom and 2 side mount options
- Unhanded brackets
- Fixing hardware included for 9301-E/9308-E
- DZ - 12 hours salt spray test

- Zestaw kątowników montażowych dla serii 9301-E/9308-E/7957
- 4 warianty do montażu do dna i 2 warianty do montażu do boku
- Kątowniki uniwersalne
- Elementy złączne w dostawie dla 9301-E/9308-E
- DZ - 12-godzinny test w mgłę solnej

- Sada montážní úhelníku pro 9301-E/9308-E/7957
- 4 možnosti montáže ke dnu a 2 možnosti boční montáže
- Univerzální úhelníky
- Spojovací materiál je součástí dodávky pro 9301-E/9308-E
- DZ – 12 hodin v solné mže



634xx	W (kg)
DZ63412	1.35
DZ63416	1.77
DZ63422	2.19
DZ63428	3.15

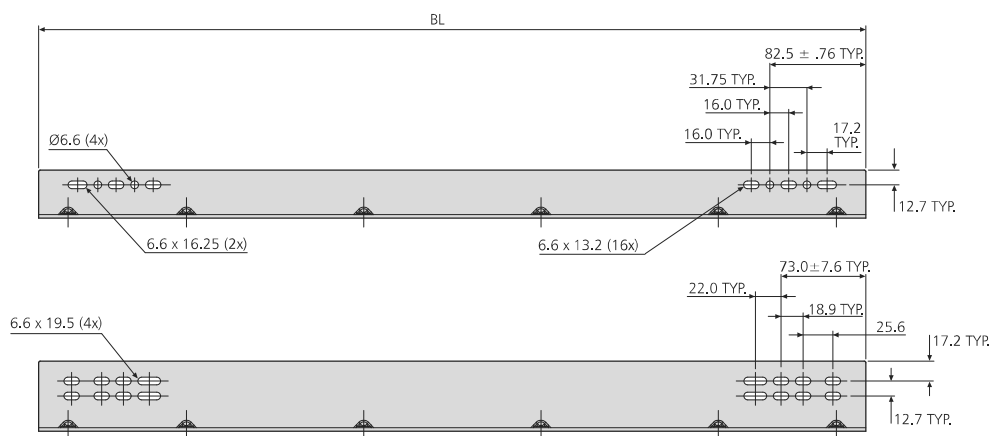
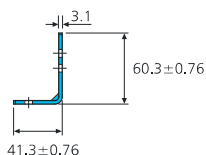

### Bracket lengths (BL):

305mm, 406mm, 559mm, 711mm

### Kit includes:

2 x brackets  
4 x 6.4 x 15.9 hex head screws  
4 x 6.4 hex head nuts and lock washers

Four bracket lengths can be used, either individually or in combination, to cover all slide lengths. See chart to determine number of bracket kits required.

The fixings included will not fit the 7957 slide. We recommend using M6 screws, or order a fixing kit from Accuride, order code 22409611.

### Długości kątowników (BL):

305 mm, 406 mm, 559 mm, 711 mm

### Zestaw zawiera:

2 x kątowniki  
4 x 6,4 x 15,9 wkręty z łbami sześciokątnymi  
4 x 6,4 nakrętki sześciokątne i podkładki zabezpieczające

Mogą zostać użyte cztery długości kątowników, indywidualnie albo w zestawieniu, aby pokryć wszystkie długości prowadnic. Liczba wymaganych zestawów kątowników – patrz tabela.

Elementy złączne w zestawie nie będą pasowały do prowadnicy 7957. Zalecamy stosowanie wkrętów M6 lub zamówienie zestawu mocującego z Accuride, kod zamówienia 22409611.

### Délky úhelníků (BL):

305 mm, 406 mm, 559 mm, 711 mm

### Sada obsahuje:

2 x úhelníky  
4 x 6,4 x 15,9 šrouby s šestihrannou hlavou  
4 x 6,4 matice s šestihrannou hlavou a těsnící podložky

Lze použít čtyři délky úhelníků, buď jednotlivě nebo v kombinaci, k pokrytí všech délek výsuvů. Stanovení počtu sad úhelníků – viz diagram.

Příložené úchyty nejsou vhodné pro výsuv 7957. Doporučujeme použít šrouby M6 anebo objednat montážní sadu od společnosti Accuride, kód objednávky 22409611.

S = Side-Mount

S = Montaż do boku

S = Boční montáž

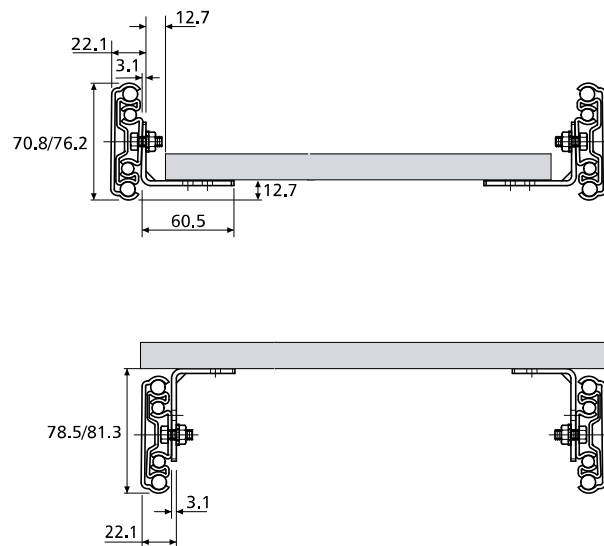

9301-E/9308-E	DZ63412	DZ63416	DZ63422	DZ63428
	S	S	S	S
930x-0012-E	1	-	-	-
930x-0014-E	1	-	-	-
930x-0016-E	-	1	-	-
930x-0018-E	-	1	-	-
930x-0020-E	-	1	-	-
930x-0022-E	-	-	1	-
930x-0024-E	-	-	1	-
930x-0026-E	-	-	1	-
930x-0028-E	-	-	-	1
930x-0030-E	-	-	-	1
930x-0032-E	-	-	-	1
930x-0034-E	2	-	-	-
930x-0036-E	2	-	-	-
9301-0040-E	1	-	1	-
9308-0040-E	1	-	1	-
9301-0042-E	1	-	-	1
9308-0042-E	1	-	-	1
9301-0044-E	1	-	1	-
9308-0044-E	1	-	-	1
9301-0048-E	1	-	-	1
9308-0048-E	1	-	-	1
9301-0054-E	-	-	2	-
9308-0054-E	-	-	2	-
9301-0060-E	-	-	1	1
9308-0060-E	-	-	1	1







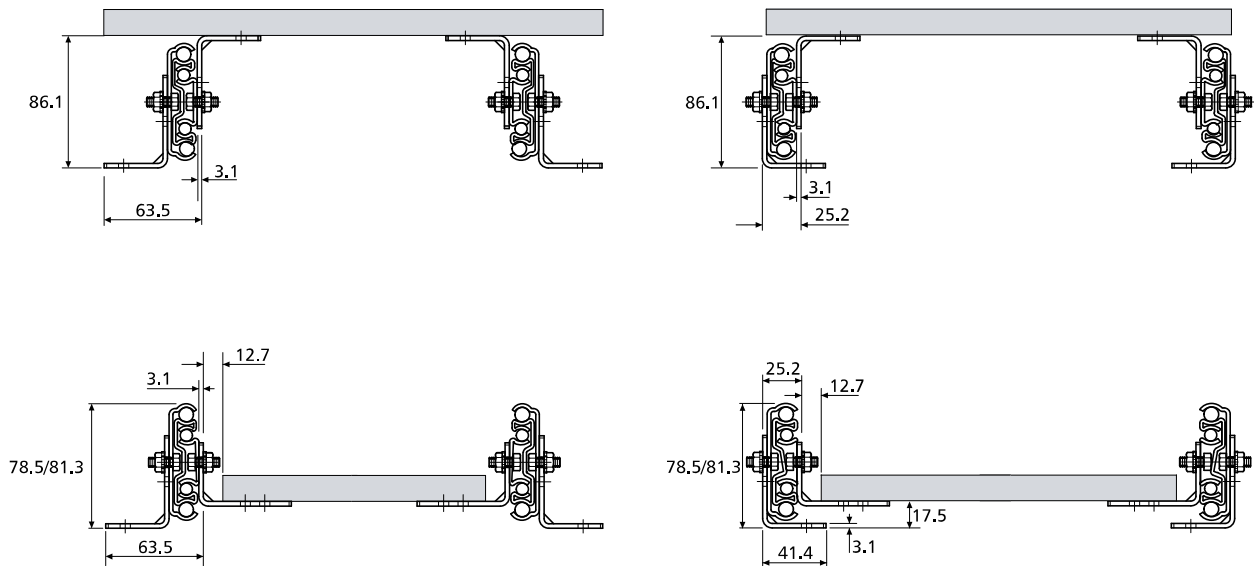





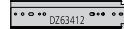

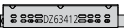
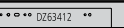
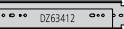

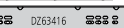
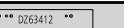
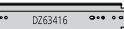

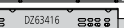

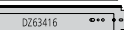



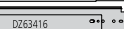
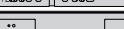





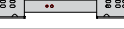

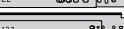

B = Bottom-Mount

B = Montáž do dna

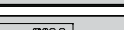
B = Montáž ke dnus



9301-E/9308-E	DZ63412	DZ63416	DZ63422	DZ63428
	B	B	B	B
930x-0012-E	2	-	-	-
930x-0014-E	2	-	-	-
930x-0016-E	-	2	-	-
930x-0018-E	-	2	-	-
930x-0020-E	-	2	-	-
930x-0022-E	-	-	2	-
930x-0024-E	-	-	2	-
930x-0026-E	-	-	2	-
930x-0028-E	-	-	-	2
930x-0030-E	-	-	-	2
930x-0032-E	-	-	-	2
930x-0034-E	4	-	-	-
930x-0036-E	4	-	-	-
9301-0040-E	2	-	2	-
9308-0040-E	3	-	1	-
9301-0042-E	2	-	1	1
9308-0042-E	3	-	-	1
9301-0044-E	2	-	2	-
9308-0044-E	3	-	-	1
9301-0048-E	2	-	-	2
9308-0048-E	3	-	-	1
9301-0054-E	-	1	3	-
9308-0054-E	1	1	2	-
9301-0060-E	-	-	2	2
9308-0060-E	-	-	3	1

	IM DZ9301/DZ9308-0012		IM DZ9301-0034
	OMDZ9301/DZ9308-0012		IM DZ9308-0034
	IM DZ9301/DZ9308-0014		OMDZ9301/DZ9308-0034
	OMDZ9301/DZ9308-0014		IM DZ9301/DZ9308-0036
	IM DZ9301/DZ9308-0016		OMDZ9301/DZ9308-0036
	OMDZ9301/DZ9308-0016		IM DZ9301/DZ9308-0040
	IM DZ9301/DZ9308-0018		OMDZ9301-0040
	OMDZ9301/DZ9308-0018		IM DZ9301/DZ9308-0042
	IM DZ9301/DZ9308-0020		OMDZ9301-0042
	OMDZ9301/DZ9308-0020		IM DZ9301/DZ9308-0044
	IM DZ9301/DZ9308-0022		OMDZ9301-0044
	OMDZ9301/DZ9308-0022		IM DZ9301/DZ9308-0048
	IM DZ9301/DZ9308-0024		OMDZ9301-0048
	OMDZ9301/DZ9308-0024		IM DZ9301/DZ9308-0054
	IM DZ9301/DZ9308-0026		OMDZ9301-0054
	OMDZ9301/DZ9308-0026		IM DZ9301/DZ9308-0060
	IM DZ9301/DZ9308-0028		OMDZ9301-0060
	OMDZ9301/DZ9308-0028		IM DZ9301/DZ9308-0062
	IM DZ9301/DZ9308-0030		OMDZ9301-0062
	OMDZ9301/DZ9308-0030		
	IM DZ9301/DZ9308-0032		
	OMDZ9301/DZ9308-0032		

7957	DZ63412-305mm		DZ63416-406mm		DZ63422-559mm		DZ63428-711mm	
	S	B	S	B	S	B	S	B
7957-0012	1	2	-	-	-	-	-	-
7957-0014	1	2	-	-	-	-	-	-
7957-0016	-	-	1	2	-	-	-	-
7957-0018	-	-	1	2	-	-	-	-
7957-0020	-	-	1	2	-	-	-	-
7957-0022	-	-	-	-	1	2	-	-
7957-0024	-	-	-	-	1	2	-	-
7957-0026	-	-	-	-	1	2	-	-
7957-0028	-	-	-	-	-	-	1	2
7957-0030	-	-	-	-	-	-	1	2
7957-0032	-	-	-	-	-	-	1	2
7957-0034	-	2	-	-	-	-	1	1
7957-0036	1	3	1	1	-	-	-	-

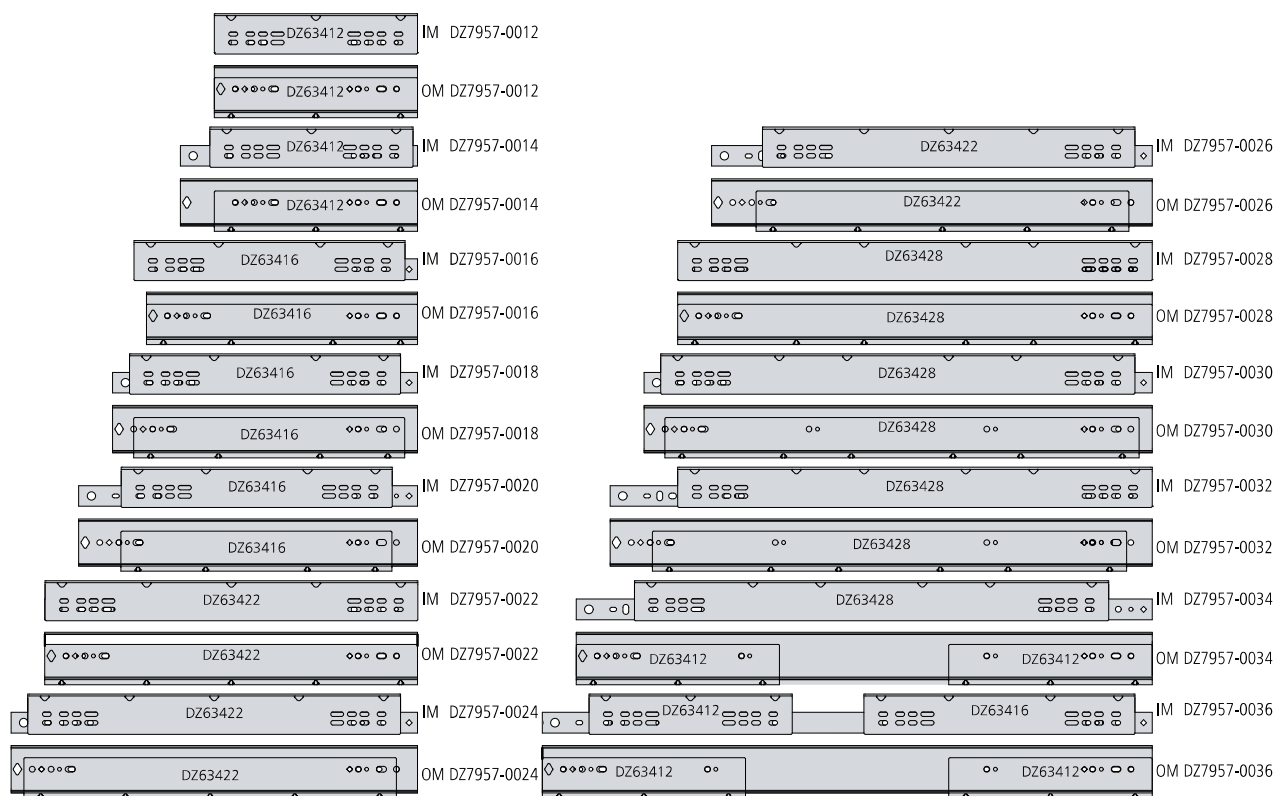
**Notes:**

- Customer supplies hardware to mount brackets to base and/or platform/drawer
- Cold rolled steel
- Dimensions for reference only
- Please refer to 2D CAD drawings for dimensional tolerances

**Uwagi:**

- Klient dostarcza elementy złączne do montażu kątowników do podstawy i/lub platformy/szuflady
- Stal walcowana na zimno
- Wymiary tylko w celach orientacyjnych
- Tolerancje wymiarów zawierają rysunki 2D CAD

**Poznámky:**

- Zákazník dodá spojovací materiál k montáži úhelníků k základně a/nebo pod desku/k zásuvce
- Ocel válcovaná za studena
- Rozměry jsou pouze k odkazu
- Rozměrové tolerance najdete na 2D CAD výkresech